

DATE	REVISION NUMBER	INITIALS	Initial Release
2014/02/11	A0 (EVT V00)	Andrew Chen	Initial draft
2014/04/16	B0 (DVT)	Andrew Chen	Add C35, R65,R66
2014/05/29	V01(MP)	Andrew Chen	MP RELEASE

PCB design specification

1. Substrate: FR4 ROHS compliant, High TG 140 degree.
2. Solder mask, color=BLUE, Silkscreen color=WHITE
3. Surface finish to be Immersion Nickel/Gold (ENIG) with 1-2 u"
4. Start with 1/2 oz. copper on all layers.



		Laird Technologies CPBU 5F, No. 257, Dong Sec. 1, Guangming 6th Rd, Zhubei City, Hsinchu County 30264, Taiwan (R.O.C)	
Project Name :	Schematic Name :	Drawing By :	
DVK-BT830	DVK-BT830	Andrew_Chen	
Date :	Sheet	of	Revision :
2013/05/29	2	4	V01

J10 for FTDI (USB to TTL 232 Cable)

FTDI (USB to TTL 232 Cable)

NOPOP (PIN HEADER, 2.54mm 1X6P)

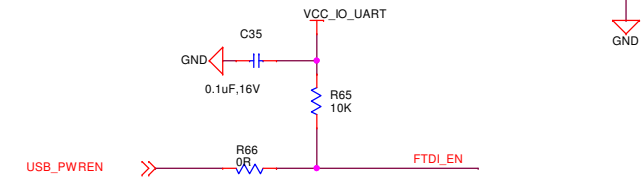
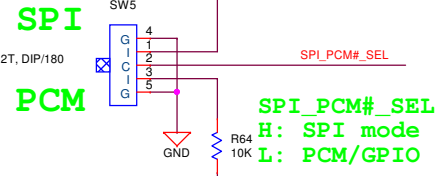
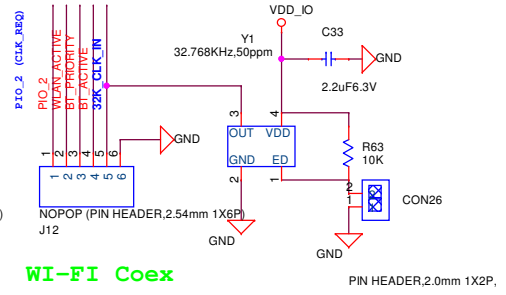
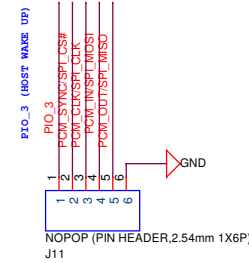
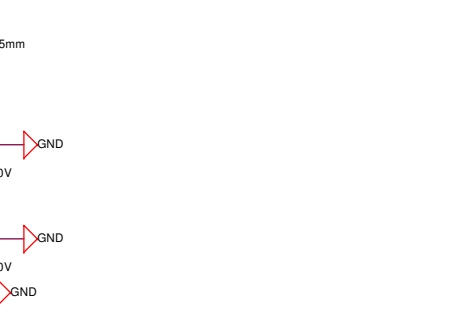
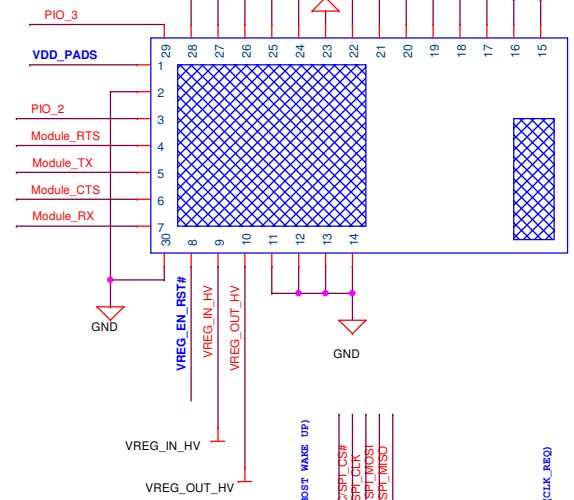
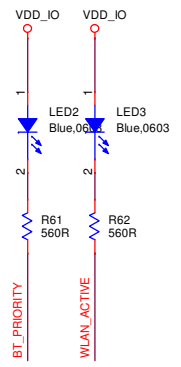
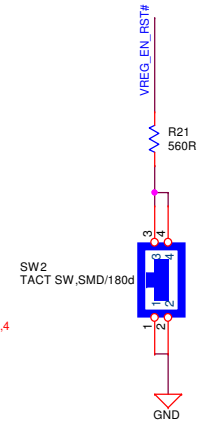
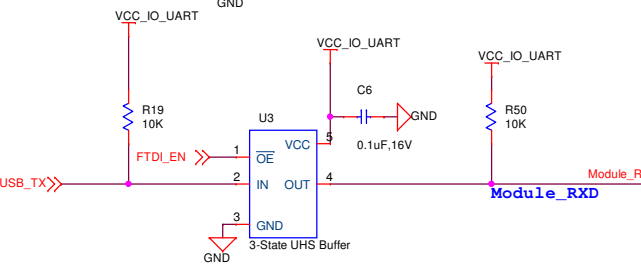
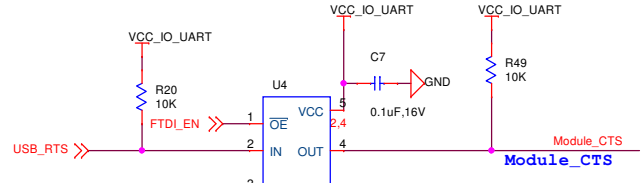
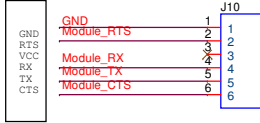
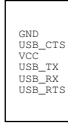
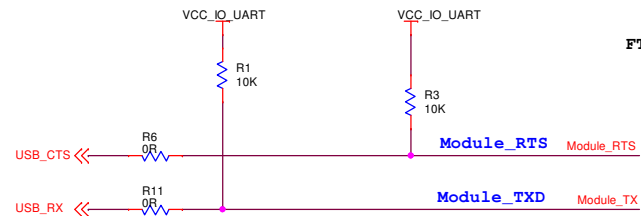

PCM

WI-FI Coex

ON:
turn off 32KHz.

		Laird Technologies CPBU 5F, No. 257, Dong Sec. 1, Guangming 6th Rd, Zhubei City, Hsinchu County 30264, Taiwan (R.O.C)	
Project Name :	DVK-BT830	Schematic Name :	DVK-BT830
Drawing By :	Andrew_Chen	Date :	2013/05/29
Sheet 3 of 4		Revision : V01	

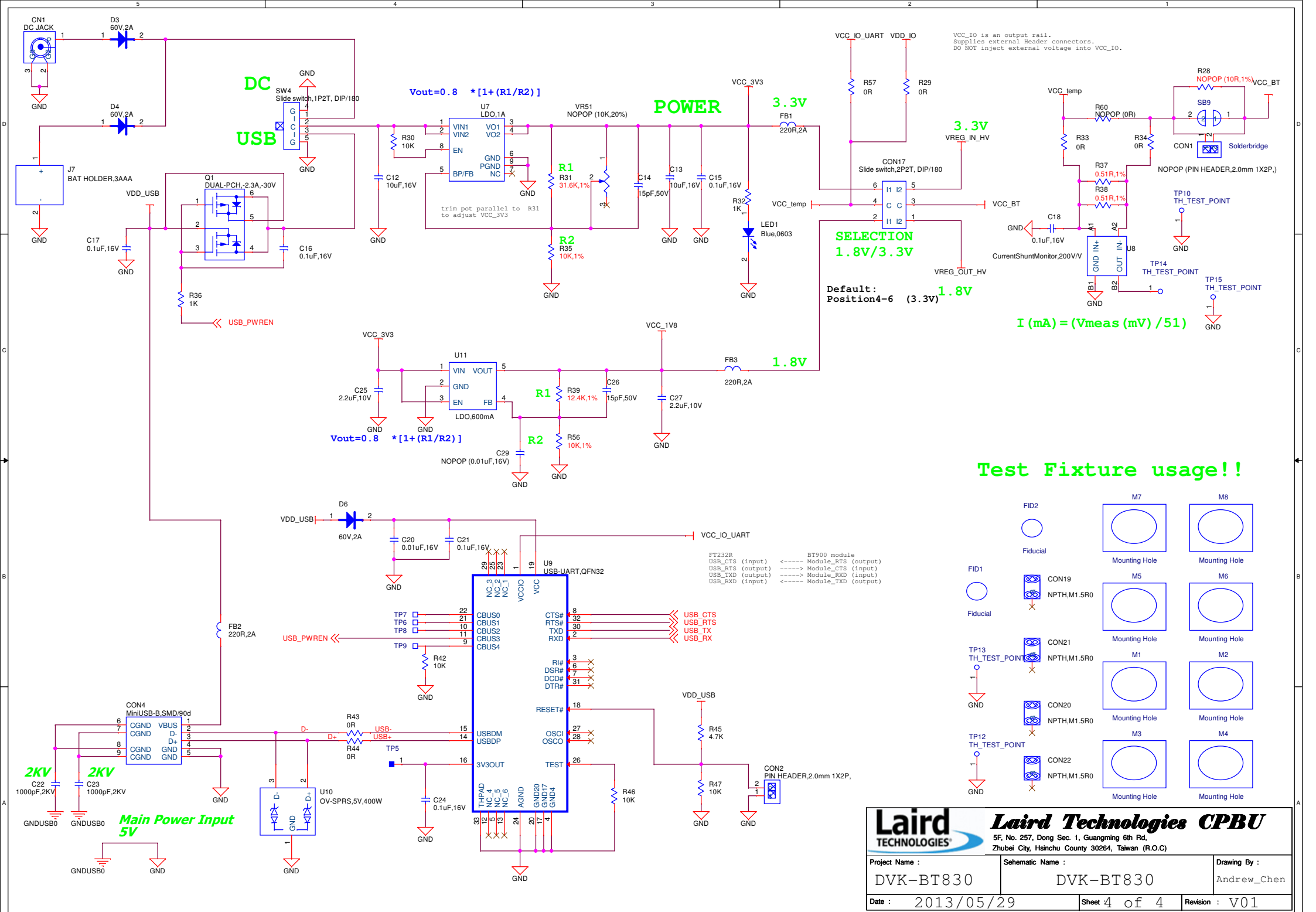

VCC_IO is an output rail.
Supplies external Header connectors.
DO NOT inject external voltage into VCC_IO.

DC
USB

POWER

SELECTION
1.8V/3.3V

I (mA) = (Vmeas (mV) / 51)

Test Fixture usage!!

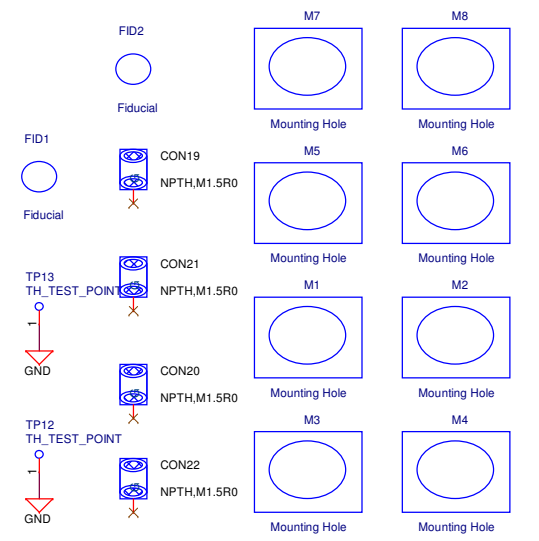

		Laird Technologies CPBU 5F, No. 257, Dong Sec. 1, Guangming 6th Rd, Zhubei City, Hsinchu County 30264, Taiwan (R.O.C)	
Project Name :	DVK-BT830	Schematic Name :	DVK-BT830
Drawing By :	Andrew_Chen	Date :	2013/05/29
Sheet	4	of	4
Revision :	V01		